



**NARROW ROW
RESIDUE MANAGER
OPERATOR'S MANUAL
PART IDENTIFICATION**

2565-694_REV_F 07/2021



YETTER MANUFACTURING CO.
FOUNDED 1930

Colchester, IL 62326-0358
Toll free: 800/447-5777
309/776-3222 (Fax)
Website: www.yetterco.com
E-mail: info@yetterco.com

YETTER

FOREWORD

You've just joined an exclusive but rapidly growing club.

For our part, we want to welcome you to the group and thank you for buying a Yetter product.

We hope your new Yetter products will help you achieve both goals-increase your productivity and increase your efficiency so that you may generate more profit.

This operator's manual has been designed into four major sections: Foreword, Safety Precautions, Installation Instructions and Parts Breakdown.



This **SAFETY ALERT SYMBOL** indicates important safety messages in the manual. When you see this symbol, be alert to the possibility of **PERSONAL INJURY** and carefully read the message that follows.

The word **NOTE** is used to convey information that is out of context with the manual text. It contains special information such as specifications, techniques and reference information of a supplementary nature.

The word **IMPORTANT** is used in the text when immediate damage will occur to the machine due to improper technique or operation. Important will

apply to the same information as specified by note only of an immediate and urgent nature.

It is the responsibility of the user to read the operator's manual and comply with the safe and correct operating procedure and to lubricate and maintain the product according to the maintenance schedule in the operator's manual.

The user is responsible for inspecting his machine and for having parts repaired or replaced when continued use of the product would cause damage or excessive wear to the other parts.

It is the user's responsibility to deliver his machine to the Yetter dealer who sold him the product for service or replacement of defective parts, which are covered by the warranty policy.

If you are unable to understand or follow the instructions provided in this publication, consult your local Yetter dealer or contact:

YETTER MANUFACTURING CO.

309/776-4111

800/447-5777

309/776-3222 (FAX)

Website: www.yetterco.com

E-mail: info@yetterco.com

WARRANTY

Yetter Manufacturing warrants all products manufactured and sold by it against defects in material. This warranty being expressly limited to replacement at the factory of such parts or products as shall appear to be defective after inspection. This warranty does not obligate the Company to bear cost of labor in replacement of parts. It is the policy of the Company to make improvements without incurring obligations to add them to any unit already sold. No warranty is made or authorized to be made, other than herein set forth. This warranty is in effect for one year after purchase.

DEALER: _____

Yetter Manufacturing warrants its own products only and cannot be responsible for damages to equipment on which mounted.

SAFETY

A brief description of signal words that may be used in this manual:

CAUTION: Used as a general reminder of good safety practices or to direct attention to unsafe practices.

WARNING: Denotes a specific potential hazard.

DANGER: Denotes the most serious specific potential hazard.

SAFETY PRECAUTIONS

You can make your farm a safer place to live and work if you observe the safety precautions given. Study these precautions carefully and insist that those working with you and for you follow them.

Finally, remember this: an accident is usually caused by someone's carelessness, neglect or oversight.



WARNING

Never clean, lubricate or adjust a machine that is in motion. Always lower or block the implement before performing service.

If the machine must be serviced in the raised position, jack or block it up to prevent it from accidentally falling and injuring someone.

Do not allow riders on the tractor or implement.

Use speeds and caution dictated by the terrain being traversed. Do not operate on any slope steep enough to cause tipping or loss of control.

Be sure all personnel are clear of the immediate area before operating.

Read and understand the operator's manual and require all other persons who will operate the equipment to do the same.

Be familiar with all tractor and implement controls and be prepared to stop engine and implements quickly in an emergency.



CAUTION

Consult your implement and tractor operator's manual for correct and safe operating practices.

Beware of towed implement width and allow safe clearance.

FAILURE TO HEED MAY RESULT IN PERSONAL INJURY OR DEATH.

TABLE OF CONTENTS

Forward.....	2
Warranty.....	2
Safety Information.....	3
Bolt Torque.....	5
Installation Instructions.....	6-7
Operation.....	8
Maintenance.....	9
Parts Identification.....	10-15

BOLT TORQUE

Mounting bolts and hardware

Before operating the Residue Manager for the first time, check to be sure that all hardware is tight. Check all hardware again after approximately 50 hours of operation and at the beginning of each planting season.

All hardware used on the Residue Manager is Grade 5 unless otherwise noted. Grade 5 cap screws are marked with three radial lines on the head. If hardware must be replaced, be sure to replace it with hardware of equal size, strength and thread type. Refer to the torque values chart when tightening hardware.



Important: Over tightening hardware can cause as much damage as when under tightening. Tightening hardware beyond the recommended range can reduce its shock load capacity.

The chart below is a guide for proper torque. Use it unless a specified torque is called out elsewhere in the manual.

Torque is the force you apply to the wrench handle or the cheater bar, times the length of the handle or bar.

Use a torque wrench whenever possible.

The following table shows torque in ft. lbs. for coarse thread hardware.

SIZE DIA AND THREAD TYPE FOR	GRADE 2	GRADE 5 OR A-325	GRADE 8
1/4	8	10	14
5/16	12	20	30
3/8 - 18	25	35	50
7/16 - 14	35	65	80
1/2 - 10	55	85	125
5/8 - 12	75	125	175
3/4 - 11	105	170	235
7/8 - 9	155	265	425
1 - 8	170	445	600
1 1/8	260	570	1050
1 1/8 - 7	365	600	1480
1 1/4 - 7	515	1275	2000
1 3/8 - 6	675	1675	2700
1 1/2 - 5	900	2150	3500
1 3/4 - 5	1410	3000	5000

Lubricate all bearings and moving parts as assembled and make certain that they work freely.



WARNING: Never work around the toolbar/implement while in a raised position without using safety lockups.



CAUTION: The Residue Managers are very heavy and sharp. Pay extra attention to lifting techniques while handling and or maneuvering the opener during assembly. Failure to do so may lead to personal injury.

INSTALLATION INSTRUCTIONS

2967 – RESIDUE MANAGER

STEP 1. Build half of the row cleaner wheel assemblies as left hand wheel assemblies and half as right hand wheel assemblies. This is determined by which side of the wheel support and in which hole the wheel assembly is installed.

NOTE: Assemble one wheel as a **right hand wheel rotation** and one wheel as a **left hand wheel rotation**.

STEP 2. Choose the mounting hole in which to attach the R.M. wheels. Attach the R.M. wheels/hub/shield assemblies to the 2967-262 stem adjustment bracket using 5/8" lock washers and hex nuts. Adjust the bearing shield to top dead center, rotate slightly forward. Torque to 150 ft./lbs.

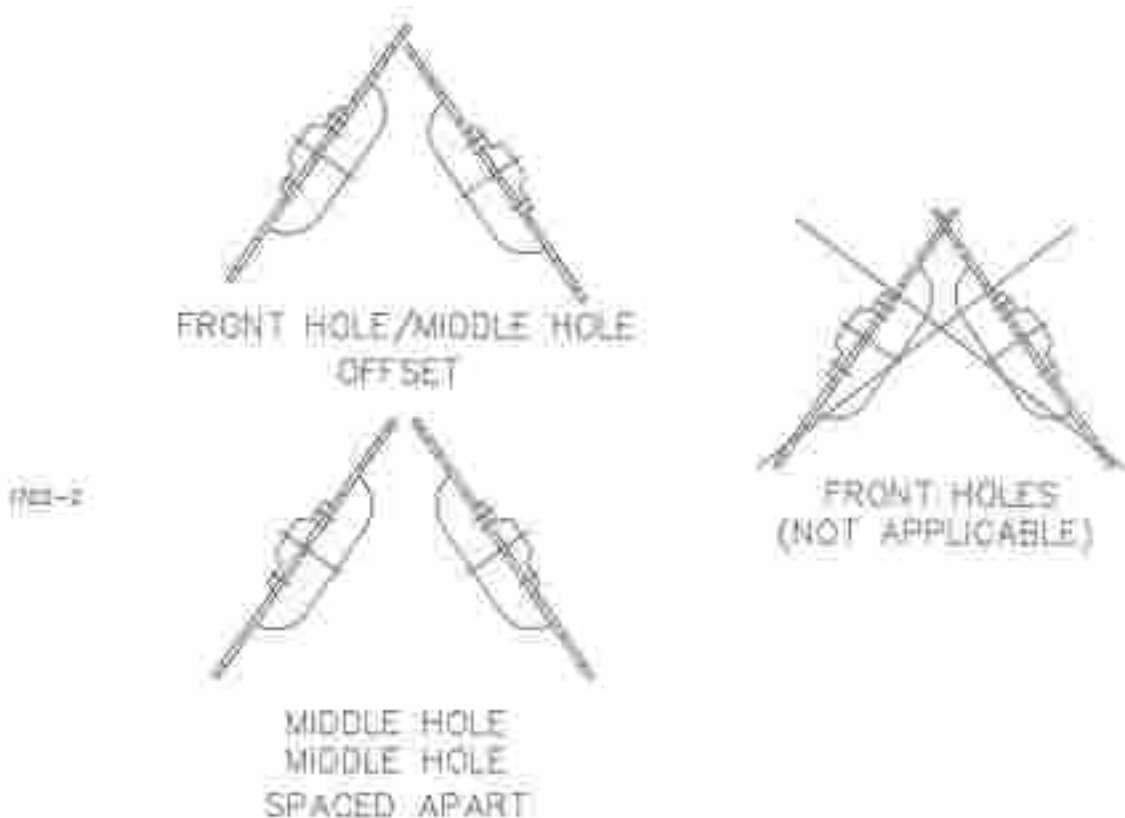

INSTALLATION INSTRUCTIONS

STEP 3. The universal model that fits on JD 7200/1700 series planters can be mounted two ways (See Figure 1). The front set of holes is to mount these models on planter units with light duty or heavy duty cast lower parallel arms. If the front set of holes is used, assemble two 1/2" x 3-1/2" bolts and spacers (2967-195 bracket assembly) to the upper and lower rear holes on the mounting bracket using 1/2" lock nuts. NOTE: Do not over-tighten. The rear set of holes is for planter units with heavy-duty welded and cast "long" lower parallel arms.

MOUNTING ARRANGEMENTS FOR JOHN DEERE 7200/1700 SERIES

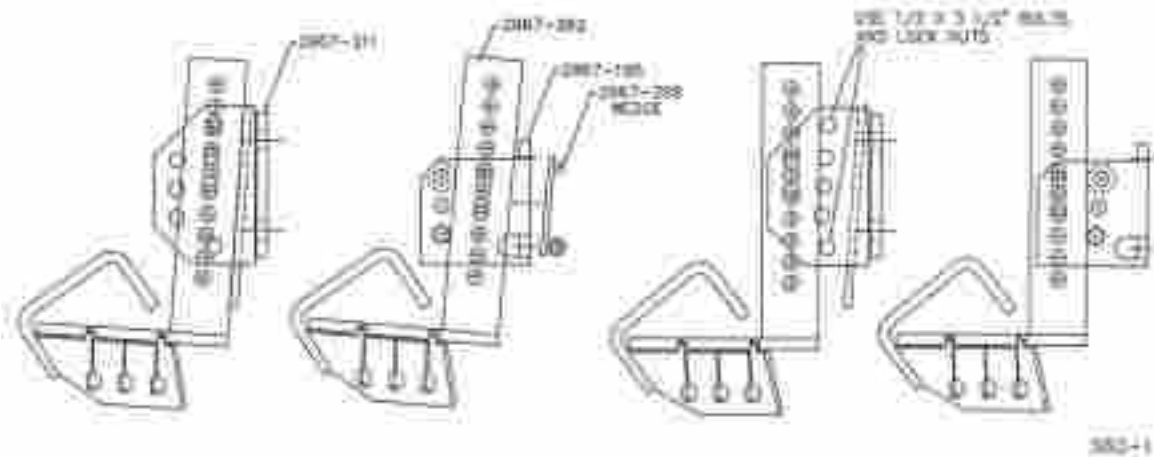

**FOR HEAVY DUTY "WELDED"
AND CAST "LONG"
LOWER PARALLEL ARMS**

**FOR LIGHT DUTY OR HEAVY DUTY CAST
LOWER PARALLEL ARMS
ALSO: JD 7000, KINZE & WHITE 6100**

FIGURE 1

STEP 4. Align the residue manager wheels to the planter opener blades. The residue manager mount bracket has slotted holes in the faceplate to move the residue manager wheels side to side; to be able to center the wheels on the seed furrow. Fully tighten mounting bolts. Torque to 85 ft./lbs.

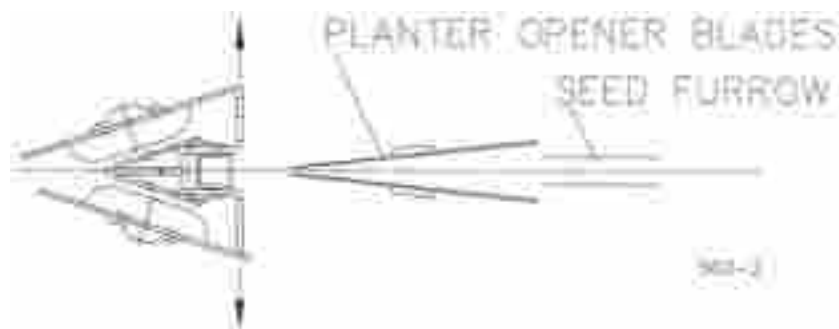

OPERATION

The **2967 Residue Manager** is designed to work in heavy residue situations especially where minimum soil movement is required. Depending on conditions and objectives, the 2967 Residue Manager can be set shallow with the teeth only engaged in the residue so as to clear heavy residue with minimal soil disturbance. Residue Managers are not recommended when surface application pre-plant herbicide is used prior to planting.

ROW CLEANER DO'S AND DON'TS

1. **DO NOT** move soil; Residue Managers are designed to move crop residue only.
2. **DO NOT** operate planter at slow speeds, ground speed affects how aggressive the spoke wheels are; operate at sufficient speed (4-6 mph) to maintain good residue flow.
3. **DO NOT** expect 100% of crop residue to be cleared, it is not necessary and would necessitate engaging the soil. The width of path cleared depends on ground conditions, depth setting and ground speed.
4. **DO** expect to see wheels occasionally quit turning, indicates ideal (shallow) setting which is not moving soil.
5. **DO** adjust toolbar frame height 20"-22" and drawbar correctly. Very important to ensure planter opener will follow ground contours properly.



Regularly inspect the residue manager for loose or worn bolts.
Repair and replace as needed.

IMPORTANT: For proper operation, the planter frame must operate level (for, aft and side to side) and at the correct height, typically 20"-22".

MAINTENANCE

Storing the Equipment

Store the machine in an area away from human activity

Store machine in RAISED position.

Install service locks on all wheel cylinders.

At the end of the season, the machine should be thoroughly inspected and prepared for storage. Repair or replace any worn or damaged components to prevent down time at the start of the next season. Store machine under cover with all parts in operating condition.

- Clean machine thoroughly to remove all dirt, debris and crop residue, which would hold moisture and cause rusting.
- Inspect machine for worn or broken parts. See your Yetter Farm Equipment dealer during the off-season so that parts or service can be acquired when machine is not needed in the field.
- Lubricate bearings as outlined in the Lubrication section
- Paint all parts which are chipped or worn and require repainting.
- Store machine in a clean, dry place with the planting unit out of the sun.
- If the machine cannot be stored inside, cover with a waterproof tarpaulin and tie securely in place.
- Do not allow children to play on or around the machine

PARTS IDENTIFICATION

PARTS IDENTIFICATION

2967-036A

CASE 800/900/950/955/1200

WILL NOT FIT 1ST YEAR IH PRODUCTION 800 (1981)

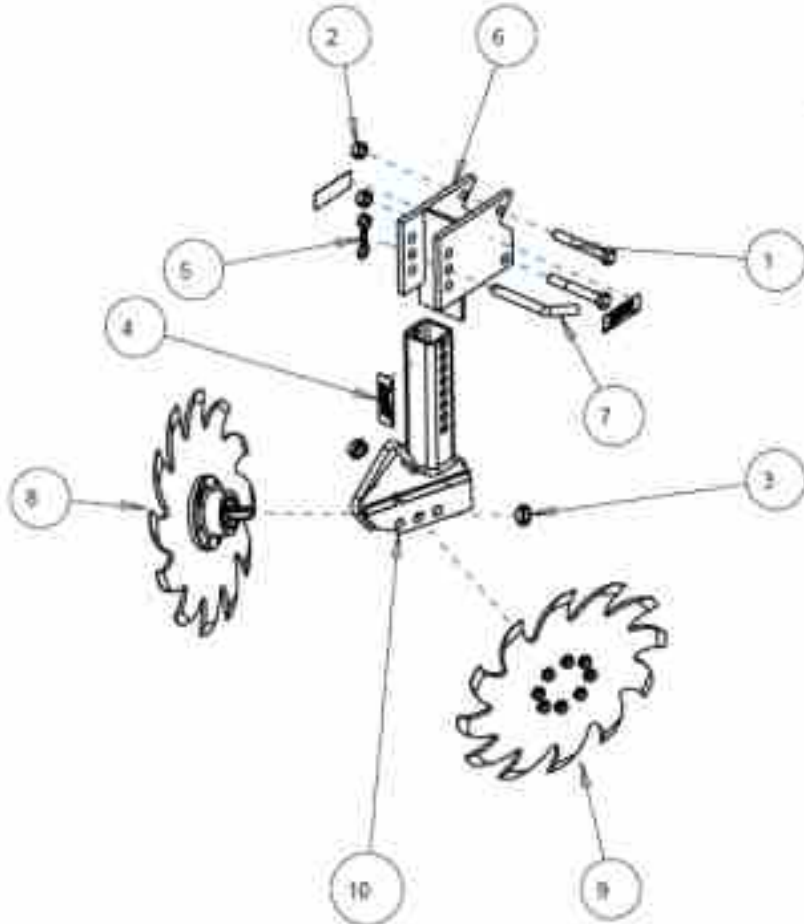

ITEM	PART NO.	DESCRIPTION	QTY.
1	2502-316	1/2-13 X 3-1/2 HHCS GR5 ZP	2
2	2520-357	1/2-13 LOCK HEX NUT, GR A, ZP	2
3	2520-467	5/8-11 HEX LOCKNUT JAM ZP	2
4	2565-179	YETTER DECAL 1" X 3"	3
5	2570-148	.120 BOWTIE LOCKING COTTER ZP	1
6	2965-203	FURROWER MOUNT BRACKET, 800	1
7	2965-305	PIN, FURROWING ATTACHMENT ZP	1
8	2966-116-ST	NR SHARKTOOTH WHEEL ASSY, R.H.	1
9	2966-117-ST	NR SHARKTOOTH WHEEL ASSY, L.H.	1
10	2966-282	NARROW R.M. STEM W.A.	1

PARTS IDENTIFICATION 2967-048A

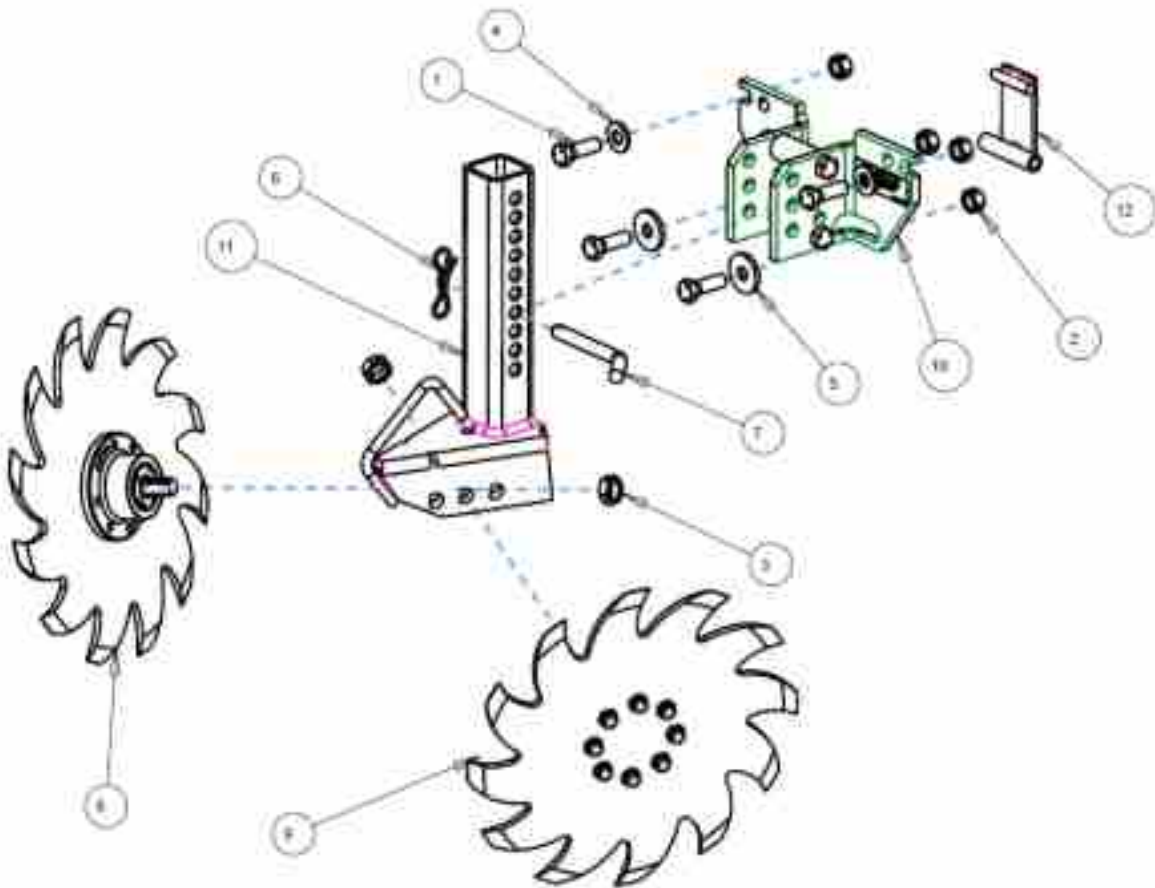

ITEM	PART NO	DESCRIPTION	QTY
1	2502-294	1/2-13 X 1-1/2 HHCS GR5 ZP	4
2	2520-357	1/2-13 LOCK HEX NUT, GR A, ZP	4
3	2520-467	5/8-11 HEX LOCKNUT JAM ZP	2
4	2526-355	1/2 FLAT WASHER HARD'ND ZP	2
5	2527-330	1/2IDX1 1/2 OD X 7 GA MA	2
6	2570-448	120 BOWTIE LOCKING COTTER ZP	1
7	2965-305	PIN, FURROWING ATTACHMENT ZP	1
8	2966-116-ST	NR SHARKTOOTH WHEEL ASSY, R.H.	1
9	2966-117-ST	NR SHARKTOOTH WHEEL ASSY, L.H.	1
10	2967-195	R.M BRACKET ASSEMBLY	1
11	2967-262	NARROW ROW R.M. STEM W.A.	1
12	2967-299	5 DEG. WEDGE W.A.	1

PARTS IDENTIFICATION

13" TAPER TOOTH SPOKE WHEEL

2966-117 (SHOWN)

2966-116

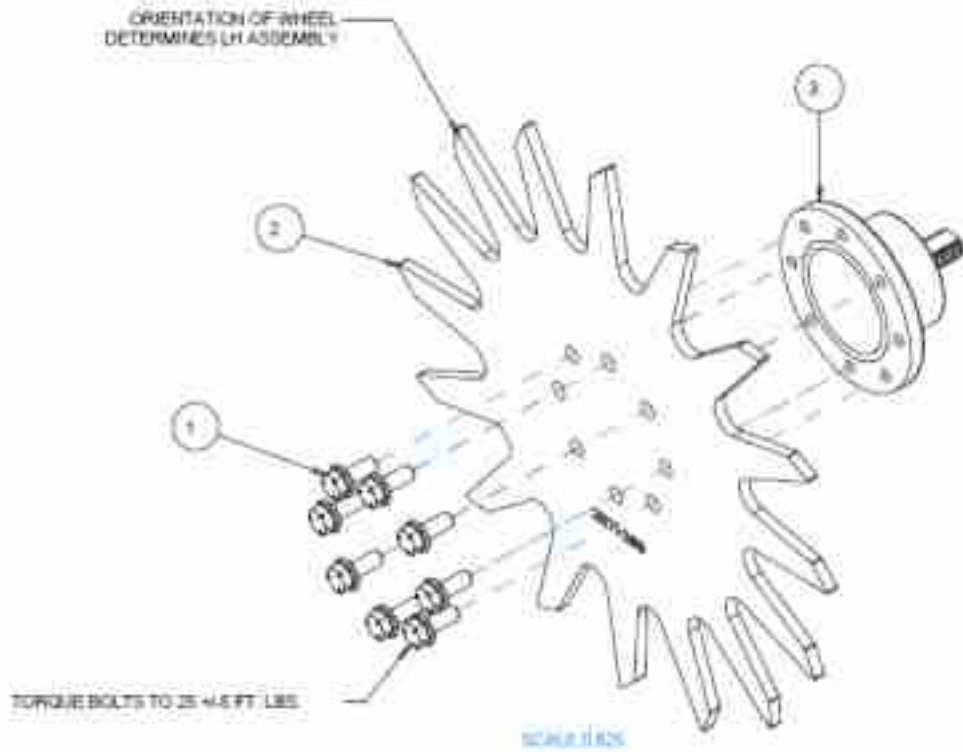

ITEM	PART NO.	DESCRIPTION	QTY
1	2502-220	5/16-18 X 3/4 HHFS GR5 ZP	8
2	2571-289	13" TAPER TOOTH SPOKE WHEEL, 8 BOLT	1
3	2965-502	HUB ASSEMBLY, 1.157 SPINDLE	1

PARTS IDENTIFICATION

13" BEVEL WHEEL

2966-117-BW (SHOWN)

2966-116-BW

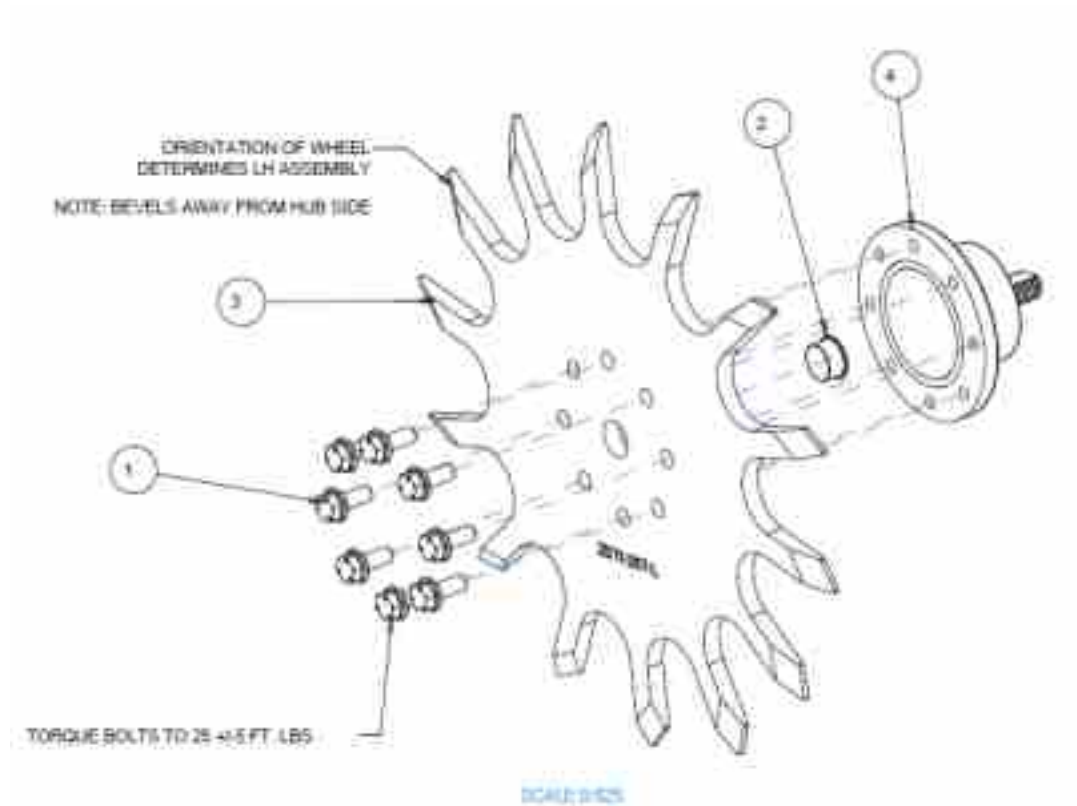

ITEM	PART NO.	DESCRIPTION	QTY
1	2502-220	5-16-18 X 3/4 HHFS GR5 ZP	8
2	2570-994	BEVEL WHEEL CENTER HOLE PLUG	1
3	2571-287-L	13" BEVEL WHEEL, 8 BOLT, LH	1
4	2965-502	HUB ASSEMBLY, 1.157 SPINDLE	1

PARTS IDENTIFICATION

13" SHARK TOOTH WHEEL

2966-117-ST (SHOWN)

2966-116-ST

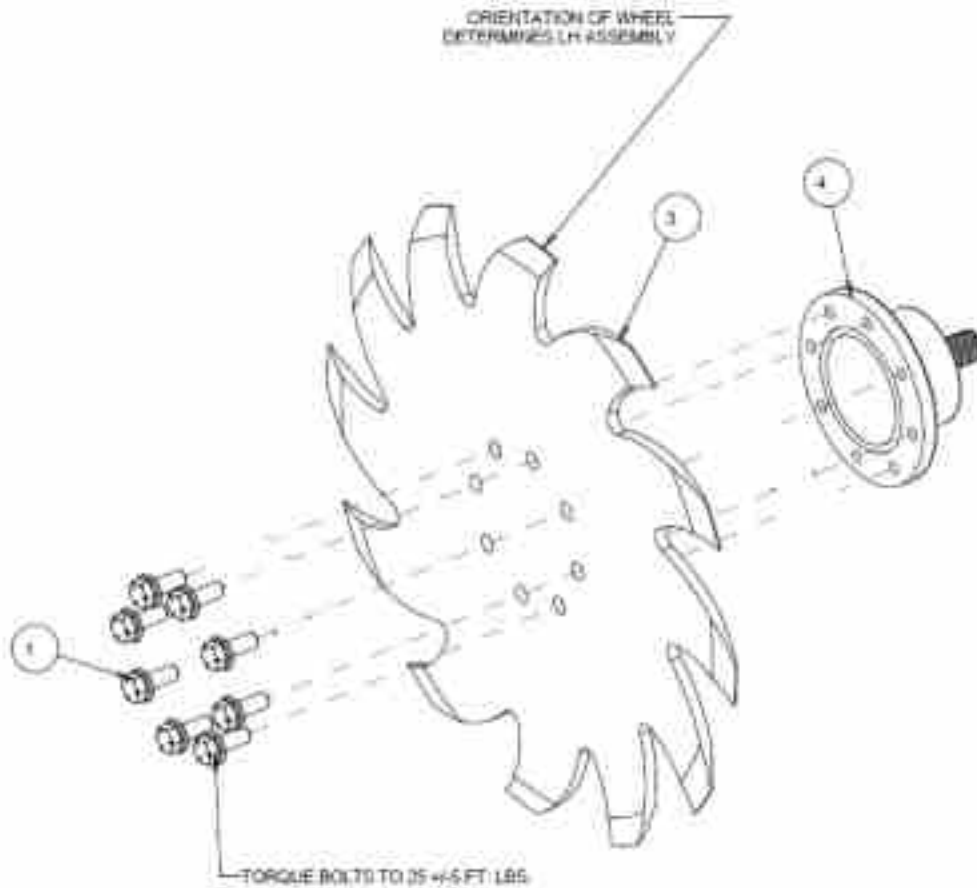

ITEM	PART NO.	DESCRIPTION	QTY
1	2502-220	5/16-18 X 3/4 HHFS GR5 ZP	8
2	2515-562	13" WHEEL COVER, BLACK	2
3	2571-286	SHARKTOOTH WHEEL, 8 BOLT	1
4	2965-502	HUB ASSEMBLY, 1.157 SPINDLE	1

PARTS IDENTIFICATION

2967-195 – RESIDUE MANAGER BRACKET ASSEMBLY

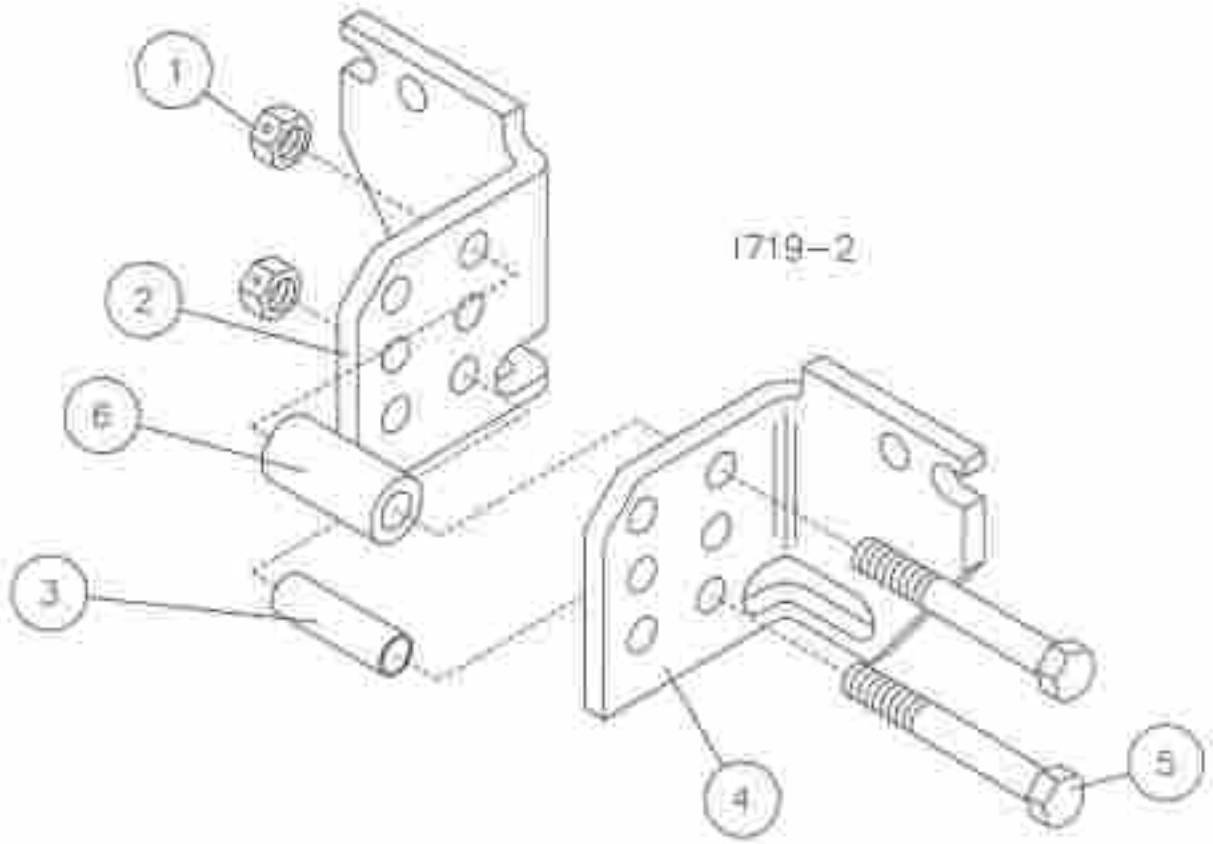

DET.	QTY	PART NO.	DESCRIPTION
1	2	2520-357	1/2-13 LOCK HEX NUT ZYD.
2	1	2967-600	R.H. R.M. MOUNT BRKT.
3	1	2967-601	SPACER, R.M. BRKT.
4	1	2967-599	L.H. R.M. MOUNT BRKT.
5	2	2502-316	1/2-13 X 3-1/2 HHCS OR 5 ZYD.
6	1	2967-629	1" DIAMETER SPACER



A Tradition of Solutions since 1930

Yetter Farm Equipment Co

PO BOX 358 109 S. McDonough

Colchester, IL 62326-0358

Phone: 309-776-4111

Toll Free: 800-447-5777

Email: info@yetterco.com

For updated models and manuals visit the Yetter website:

www.yetterco.com

© Yetter Farm Equipment Co. All Rights Reserved

2565-694_REV_F • 07/2021