

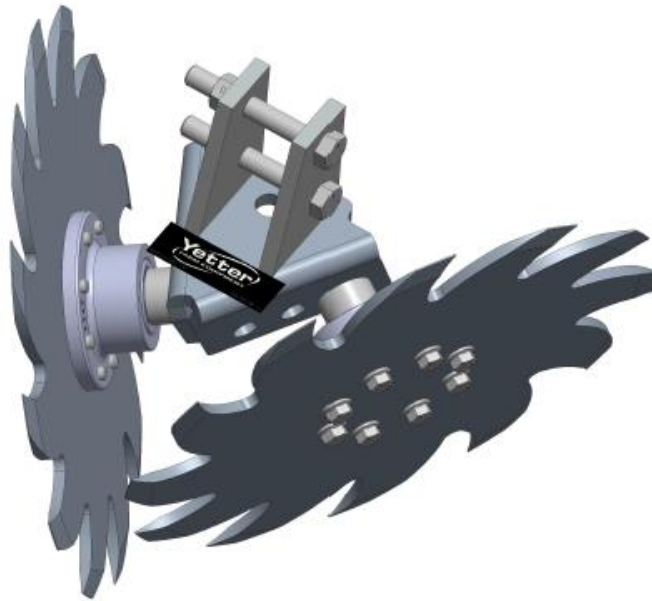

2967-081A
RESIDUE MANAGER FOR JD SCREW ADJUST
2565-448_REV_G • 09/2024



YETTER MANUFACTURING CO.
FOUNDED 1930

Colchester, IL 62326-0358
Toll free: 800/447-5777
309/776-3222 (Fax)
Website: www.yetterco.com
Email: info@yetterco.com

YETTER

FOREWORD

You've just joined an exclusive but rapidly growing club.
For our part, we want to welcome you to the group and thank you for buying a Yetter product.

We hope your new Yetter products will help you achieve both goals-increase your productivity and increase your efficiency so that you may generate more profit.

This operator's manual has been designed into four major sections: Foreword, Safety Precautions, Installation Instructions and Parts Breakdown.

This **SAFETY ALERT SYMBOL** indicates important safety messages in the manual. When you see this symbol, be alert to the possibility of **PERSONAL INJURY** and carefully read the message that follows.



DANGER: Indicates an imminently hazardous situation which, if not avoided "will" result in death or serious injury. This signal word is to be limited to the most extreme situations



WARNING: Indicates a potentially hazardous situation which, if not avoided, "could" result in death or serious injury.



CAUTION: Indicates a potentially hazardous situation, which if not avoided, "may" result in minor or moderate injury. It may also be used to alert against unsafe practices.



NOTICE: Indicates information considered important, but not hazard related (e.g., messages relating to property damage).

It is the responsibility of the user to read the operator's manual and comply with the safe and correct operating procedure and to lubricate and maintain the product according to the maintenance schedule in the operator's manual.

The user is responsible for inspecting his machine and for having parts repaired or replaced when continued use of the product would cause damage or excessive wear to the other parts.

It is the user's responsibility to deliver his machine to the Yetter dealer who sold him the product for service or replacement of defective parts, which are covered by the warranty policy.

If you are unable to understand or follow the instructions provided in this publication, consult your local Yetter dealer or contact:

YETTER MANUFACTURING CO.

309/776-4111

800/447-5777

309/776-3222 (FAX)

Website: www.yetterco.com

E-mail: info@yetterco.com

WARRANTY POLICY

Yetter Manufacturing warrants all products manufactured and sold by it against defects in material. This warranty being expressly limited to replacement at the factory of such parts or products as will appear to be defective after inspection. This warranty does not obligate the Company to bear cost of labor in replacement of parts. It is the policy of the company to make improvements without incurring obligations to add them to any unit already sold. No warranty is made or authorized to be made, other than herein set forth. This warranty is in effect for one year after purchase.

Dealer : _____

Yetter Manufacturing warrants its own products only and cannot be responsible for damage to equipment on which mounted.



SAFETY PRECAUTIONS



A brief description of signal words that may be used in this manual:

DANGER: Indicates an imminently hazardous situation which, if not avoided “will” result in death or serious injury. This signal word is to be limited to the most extreme situations.

WARNING: Indicates a potentially hazardous situation which, if not avoided, “could” result in death or serious injury.

CAUTION: Indicates a potentially hazardous situation, which if not avoided, “may” result in minor or moderate injury. It may also be used to alert against unsafe practices.

NOTICE: Indicates information considered important, but not hazard related (e.g., messages relating to property damage).

Consult your implement and tractor operator's manual for correct and safe operating practices. Be aware of towed implement width and allow safe clearance.

Safety decals are placed on the implement to alert the operator and others to the risk of personal injury or unsafe operation during normal operations and servicing.

1. The safety decals must be kept clean and in good condition to ensure that they are legible.
2. Safety decals must be replaced if they are missing or illegible.
3. When components are replaced during repair or servicing, check that the new components include the necessary safety signs.
4. Replacement safety decals may be obtained from your local dealer.



WARNING

Read these instructions carefully to acquaint yourself with the Equipment. Working with unfamiliar equipment can lead to accidents.

Never park the equipment on a steep incline or leave the equipment running unattended.

Never clean, lubricate or adjust a machine that is in motion.

Always check that straps are secure.

Make sure latches are in pinned position when moving equipment.

Do not allow children to operate this equipment.

Do not allow riders on the equipment, trailer and/or pick-up.

Use speed and caution dictated by the terrain being traversed. Do not operate on any slope steep enough to cause tipping or loss of control.

Read and understand the operator's manual and require all other persons who will operate the equipment to do the same.

If operating on public roadways, where legal, be certain all lighting is operating properly and observe all traffic laws.

Beware of increased stopping distances and control effort when operating with implements attached.

Be familiar with all controls and be prepared to stop equipment quickly in an emergency.

FAILURE TO HEED MAY RESULT IN PERSONAL INJURY OR DEATH.

BOLT TORQUE

Mounting bolts and hardware



All hardware used on the 2940 Air Adjust is Grade 5 unless otherwise noted. Grade 5 cap screws are marked with three radial lines on the head. If hardware must be replaced, be sure to replace it with hardware of equal size, strength and thread type. Refer to the torque values chart when tightening hardware.



NOTICE: Over tightening hardware can cause as much damage as when under tightening. Tightening hardware beyond the recommended range can reduce its shock load capacity.

The chart below is a guide for proper torque. Use it unless a specified torque is called out elsewhere in the manual. Torque is the force you apply to the wrench handle or the cheater bar, times the length of the handle or bar. Use a torque wrench whenever possible.

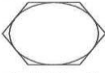
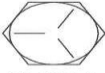
The following table shows torque in ft. lbs. for coarse thread hardware.

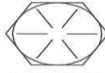
BOLT DIA. AND THREADS PER INCH		 OR 	
	GRADE 2	GRADE 5 A-325	GRADE 8
3/8-16	25	35	50
7/16-14	35	55	80
1/2-13	55	85	125
9/16-12	75	125	175
5/8-11	105	170	235
3/4-10	185	305	425
7/8-9	170	445	690
1-8	260	670	1030
1 1/8-7	365	900	1460
1 1/4-7	515	1275	2060
1 3/8-6	675	1675	2700
1 1/2-6	900	2150	3500
1 3/4-5	1410	3500	5600

INSTALLATION

1. Be sure to install the 3/4" spacers when assembling the spoke wheel and bearing assembly. Using the 5/8" nut, secure the wheel to the bracket. Torque 180 ft.lbs. Stagger spoke wheels so that half of the rows have the left wheel leading and half of the rows have the right wheel leading.
2. Attach the RESIDUE WHEEL assembly to the screw adjust bracket using the two 1/2" x 3 1/2" bolts and lock nuts.

MAINTENANCE

After a few hours use, check all bolts to make sure they are tight.

PARTS IDENTIFICATION 2967-081A-ST

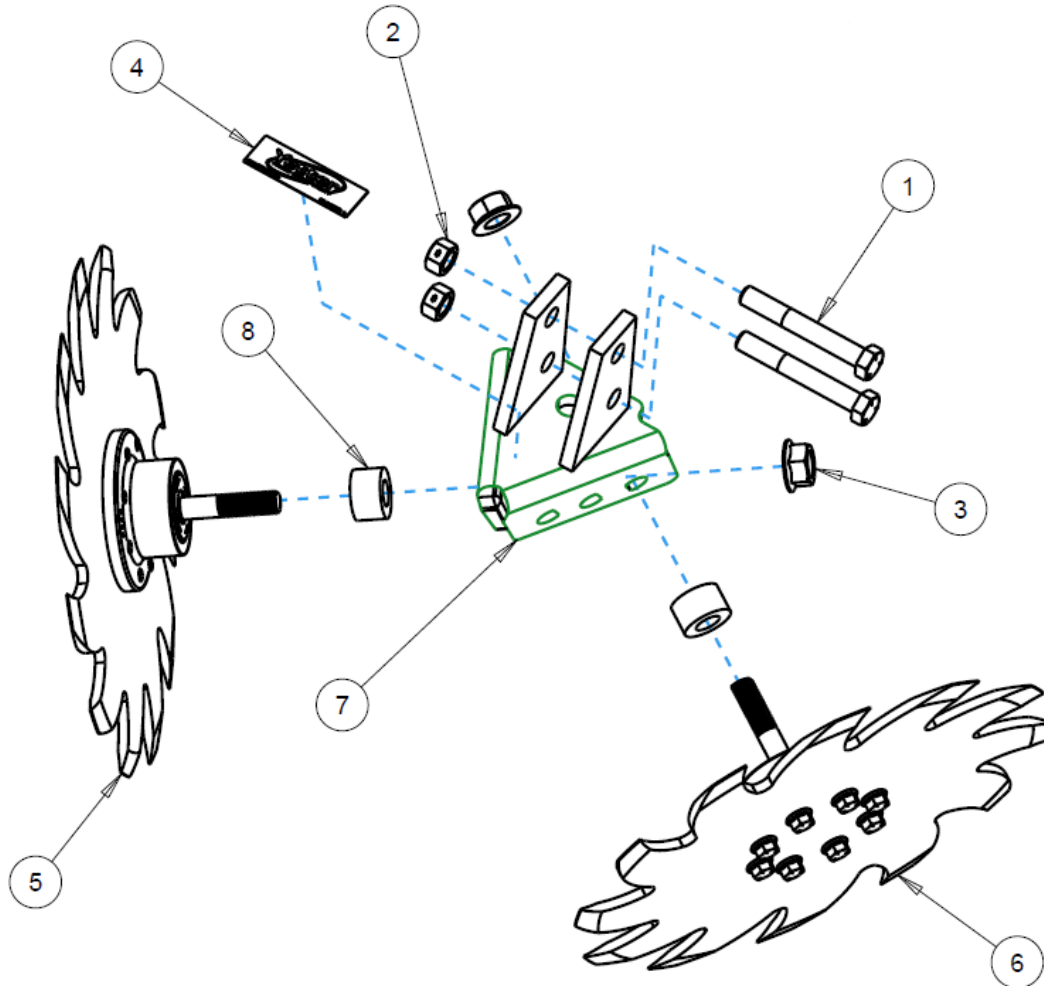

ITEM	PART NO.	DESCRIPTION	QTY
1	2502-316	1/2-13 X 3-1/2 HHCS GRADE 5	2
2	2520-357	1/2-13 LOCK NUT GRADE A	2
3	2520-465	5/8-11 FLANGE NUT GRADE 8	2
4	2965-179	YETTER DECAL	1
5	2966-102-ST	RIGHT HAND SHARK TOOTH WHEEL ASSEMBLY	1
6	2966-103-ST	LEFT HAND SHARK TOOTH WHEEL ASSEMBLY	1
7	2967-257	JD SCREW ADJUST MOUNT BRACKET	1
8	2967-302	SPACER 3/4"	2

PARTS IDENTIFICATION
2966-102 RIGHT HAND SPOKE WHEEL (SHOWN)
2966-103 LEFT HAND SPOKE WHEEL

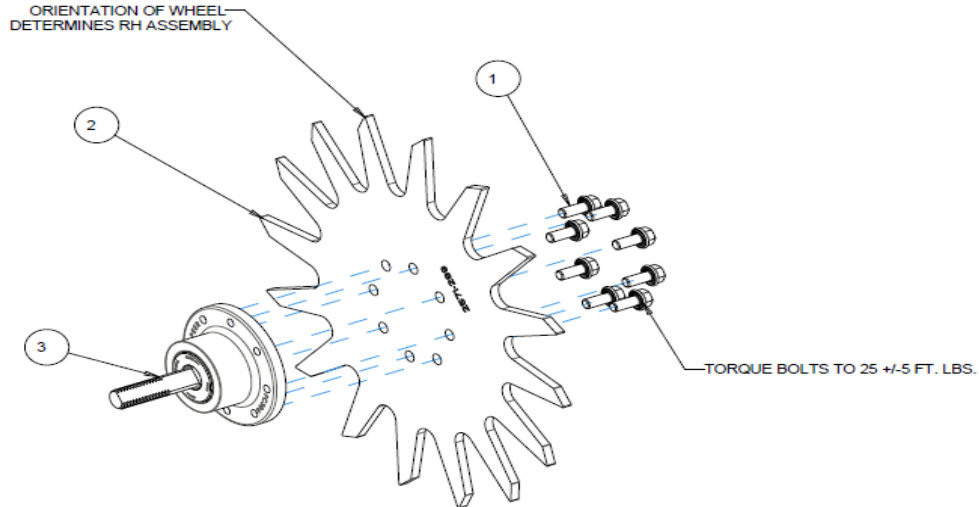

ITEM	PART NO.	DESCRIPTION	QTY
1	2502-220	5/16-18 X 3/4 HHFS GR5 ZP	8
2	2571-289	13" TAPER TOOTH SPOKE WHEEL, 8 BOLT	1
3	2965-501	HUB ASSEMBLY, 2.406 SPINDLE	1

2966-102-BW RIGHT HAND BEVELED WHEEL (SHOWN)
2966-103-BW LEFT HAND BEVELED WHEEL

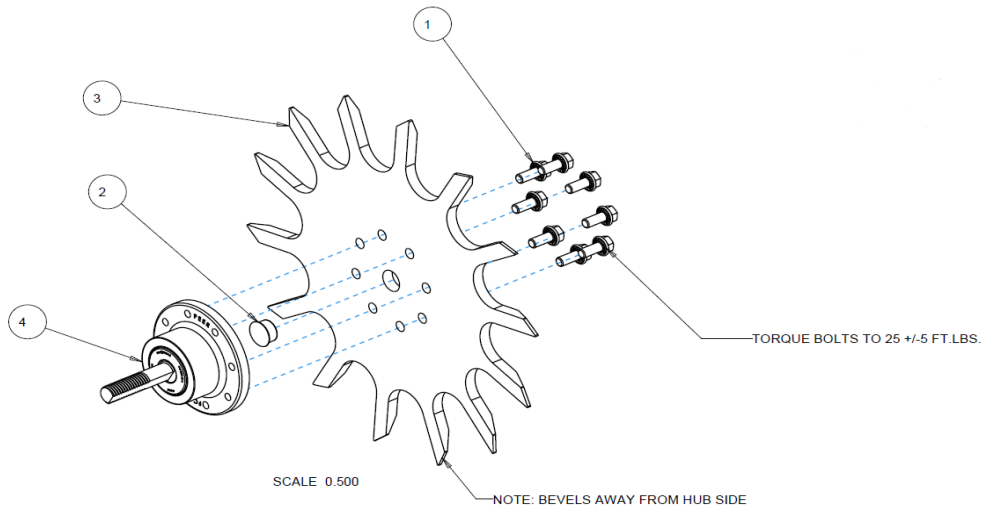

ITEM	PART NO.	DESCRIPTION	QTY
1	2502-220	5/16-18 X 3/4 HHFS GR5 ZP	8
2	2570-994	BEVEL WHEEL CENTER HOLE PLUG	1
3	2571-287-R	13" BEVEL WHEEL, 8 BOLT, RH	1
4	2965-501	HUB ASSEMBLY, 2.406 SPINDLE	1

PARTS IDENTIFICATION
2966-102-ST RIGHT HAND SHARK WHEEL (SHOWN)
2966-103-ST LEFT HAND SHARK WHEEL

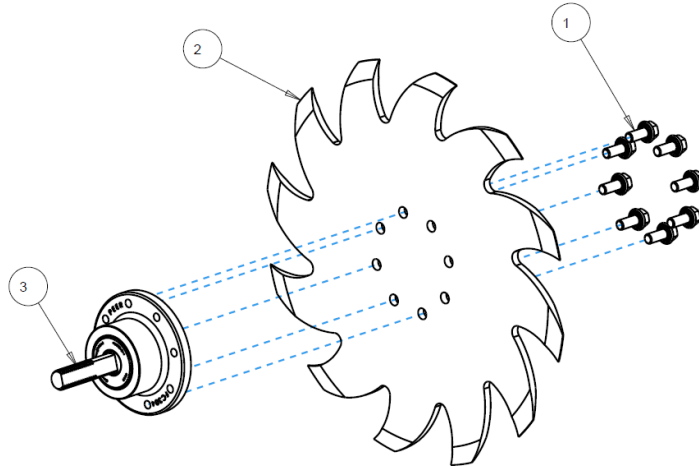

ITEM	PART NO.	DESCRIPTION	QTY
1	2502-220	5/16-18 X 3/4 HHFS GR5 ZP	8
2	2571-286	SHARKTOOTH WHEEL, 8 BOLT	1
3	2965-501	HUB ASSEMBLY, 2.406 SPINDLE	1

2966-102-STF
RIGHT HAND SHARKTOOTH FINGER WHEEL ASSEMBLY

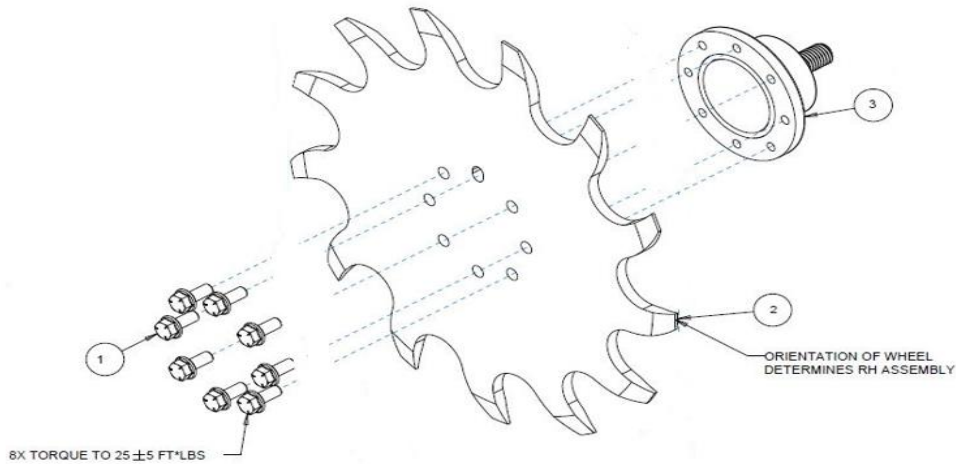

ITEM	QTY	PART NO.	DESCRIPTION
1	8	2502-220	5/16-18 X 3/4 HHFS BOLT GR5
2	1	2571-600	SHARKTOOTH FINGER WHEEL
3	1	2965-501	HUB ASSEMBLY 2.406" SPINDLE

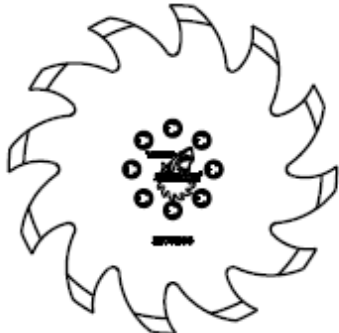

SHARKTOOTH WHEEL ASSEMBLY
 RIGHT HAND 2966-140-ST(SHOWN)
 LEFT HAND 2966-141-ST



SHARKTOOTH WHEEL ASSEMBLY W/FLOATER WHEEL
 RIGHT HAND 2966-140-ST-FW(SHOWN)
 LEFT HAND 2966-141-ST-FW

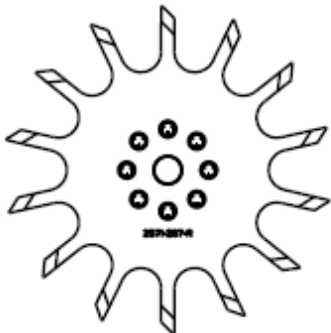

BEVEL WHEEL ASSEMBLY
 RIGHT HAND 2966-140-BW(SHOWN)
 LEFT HAND 2966-141-BW



BEVEL WHEEL ASSEMBLY W/FLOATER WHEEL
 RIGHT HAND 2966-140-BW-FW(SHOWN)
 LEFT HAND 2966-141-BW-FW

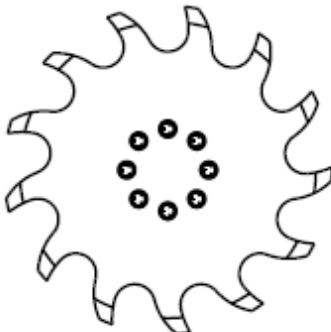

SHARKTOOTH FINGER WHEEL ASSEMBLY
 RIGHT HAND 2966-140-STF(SHOWN)
 LEFT HAND 2966-141-STF

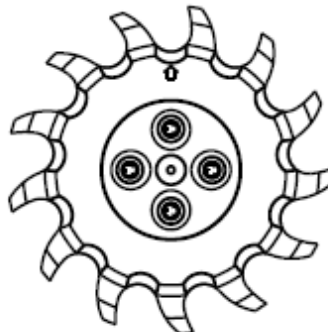

SHARKTOOTH FINGER WHEEL ASSEMBLY W/FLOATER WHEEL
 RIGHT HAND 2966-140-STF-FW(SHOWN)
 LEFT HAND 2966-141-STF-FW

ISO2966-140_ASSEMBLIES

FIELD SERVICE KITS

- 2965-119 - SERVICE KIT FOR 2570-740-2.812 D-BOLT
- 2965-120 - SERVICE KIT FOR 2570-742-3.812 D-BOLT
- 2965-121 - SERVICE KIT FOR 2570-766-2.562 D-BOLT

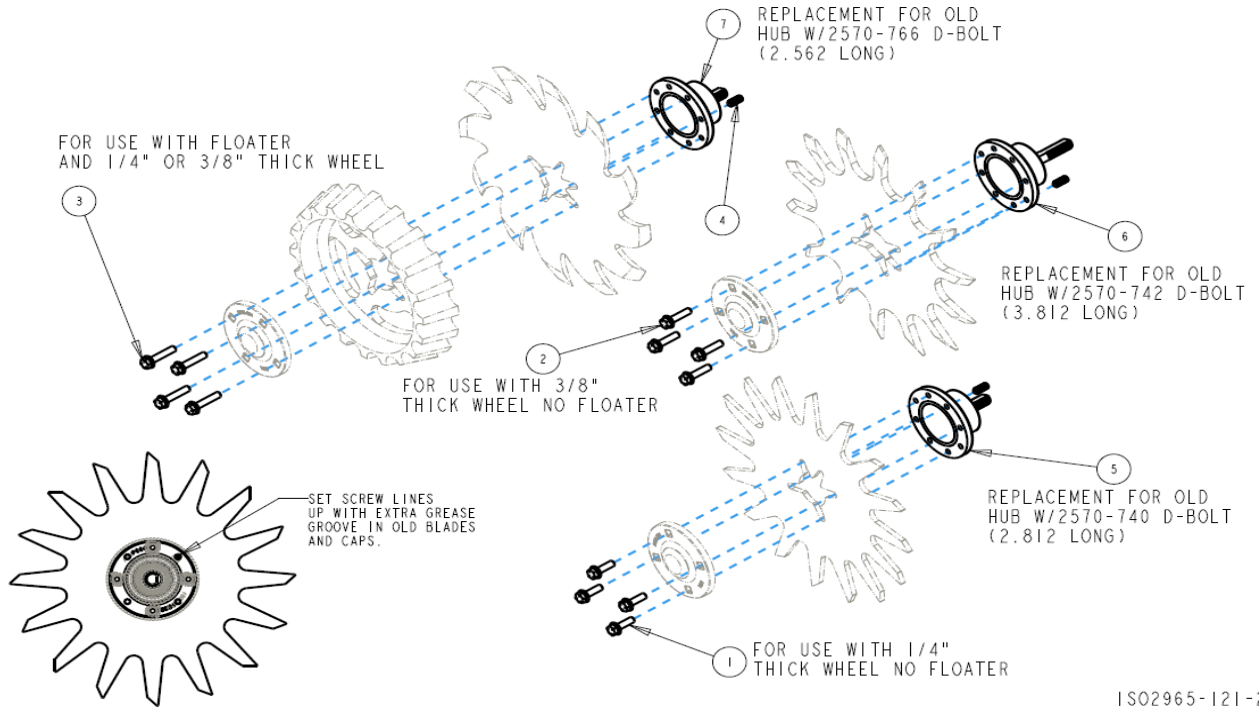

ISO2965-121-2

ITEM	PART NO	DESCRIPTION	QTY
1	2502-221	5/16-18 X 1 HHFS GRADE 5	4
2	2502-222	5/16-18 X 1-1/4 HHFS GRADE 5	4
3	2502-225	5/16-18 X 1-1/2 HHFS GRADE 5	4
4	2940-560	SET SCREW	1
5	2965-500	HUB ASSEMBLY 1.406 SPINDLE	1
6	2965-501	HUB ASSEMBLY 2.406 SPINDLE	1
7	2965-502	HUB ASSEMBLY 1.157 SPINDLE	1



ITEM	PART NO	DESCRIPTION	QTY
1	2505-207	5/16-18 X 1-1/4 CARRIAGE HEAD BOLT GRADE 5	4
2	2520-206	5/16-18 FLANGE LOCK NUT	4
3	2570-742	D-BOLT FLANGE HEAD 5/8-11 X 3.812 GRADE 8	1
4	2965-128	HUB/BEARING ASSEMBLY	1
	2550-069	SEAL	1
	2570-594	BEARING	1
	2570-715	INSERT	1
	2965-351	HUB	1
	2533-110	GREASE FITTING	1
5	2965-352	HUB CAP	1
6	2967-602	SHARK TOOTH WHEEL	1
7	2520-465	5/8-11 FLANGE LOCK NUT GRADE 8	1

NOTES

NOTES



A Tradition of Solutions since 1930

Yetter Farm Equipment Co

PO BOX 358 109 S. McDonough

Colchester, IL 62326-0358

Phone: 309-776-4111

Toll Free: 800-447-5777

Email: info@yetterco.com

For updated models and manuals visit the Yetter website:

www.yetterco.com

© Yetter Farm Equipment Co. All Rights Reserved

2565-448_REV_G -09/2024